



## SSCN5551GS6

### High Frequency High Gain NPN Power BJT

#### ➤ Features

VCB	VCE	VEB	IC
180V	160V	6V	600mA

#### ➤ Description

This device is designed for general-purpose high-voltage amplifiers and gas discharge display drivers. It is Ideal for medium power amplification and switching.

#### ➤ Applications

- General-purpose high-voltage amplifiers
- Gas discharge display drivers
- Medium power amplification and switching

#### ➤ Ordering Information

Device	Package	Shipping
SSCN5551GS6	SOT-23	3000/Reel

#### ➤ Pin configuration

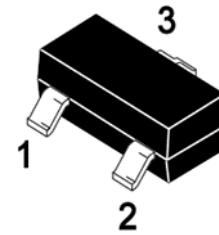

**SOT-23**

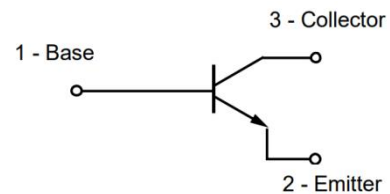

**Circuit Diagram**

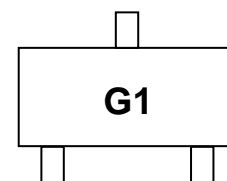

**Marking(Top View)**



➤ **Absolute Maximum Ratings**( $T_A=25^{\circ}\text{C}$  unless otherwise noted)

Parameter	Symbol	Value	Unit
Collector-Base Voltage	$V_{CB0}$	180	V
Collector- Emitter Voltage	$V_{CEO}$	160	V
Emitter-Base Voltage	$V_{EBO}$	6	V
Collector Current-Continuous	$I_C$	600	mA
Collector Power Dissipation	$P_C$	625	mW
Junction Temperature	$T_J$	150	$^{\circ}\text{C}$
Storage Temperature	$T_{STG}$	-55 to 150	$^{\circ}\text{C}$

➤ **Electrical Characteristics** ( $T_A=25^{\circ}\text{C}$  unless otherwise noted)

Parameter	Symbol	Test Conditions	Min.	Typ.	Max.	Unit
Collector-Base Breakdown Voltage	$BV_{CB0}$	$I_C=0.1\text{mA}, I_E=0$	180			V
Collector-emitter Breakdown Voltage	$BV_{CEO}$	$I_C=1\text{mA}, I_B=0$	160			V
Emitter -Base Breakdown Voltage	$BV_{EBO}$	$I_E=0.1\text{mA}, I_C=0$	6			V
Collector Cutoff Current	$I_{CB0}$	$V_{CB}=120\text{V}, I_E=0$			0.05	$\mu\text{A}$
Emitter Cutoff Current	$I_{EBO}$	$V_{EB}=4\text{V}, I_C=0$			0.05	$\mu\text{A}$
DC Current Gain	$h_{FE}$	$V_{CE}=5\text{V}, I_C=10\text{mA}$	100		300	
Collector-Emitter Saturation Voltage	$V_{CE(sat)}$	$I_C=50\text{mA}, I_B=5\text{mA}$			0.5	V
Base-Emitter Saturation Voltage	$V_{BE(sat)}$	$I_C=50\text{mA}, I_B=5\text{mA}$			1.0	V
Transition frequency	$f_T$	$V_{CE}=5\text{V}, I_C=10\text{mA}$ $f=30\text{MHz}$	100		300	MHz



➤ Typical Performance Characteristics ( $T_A=25^\circ\text{C}$  unless otherwise noted)

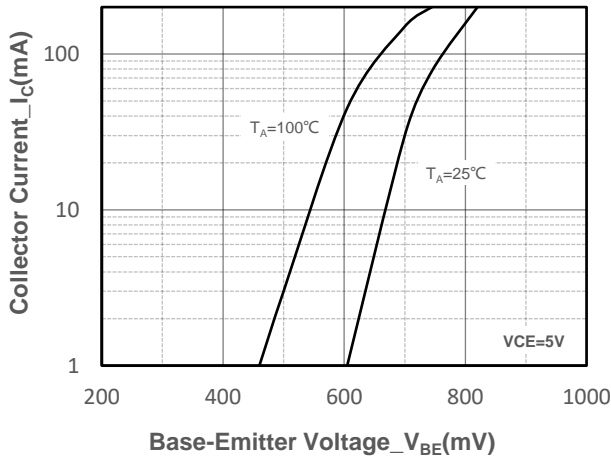

Collector Current vs. Base-Emitter Voltage

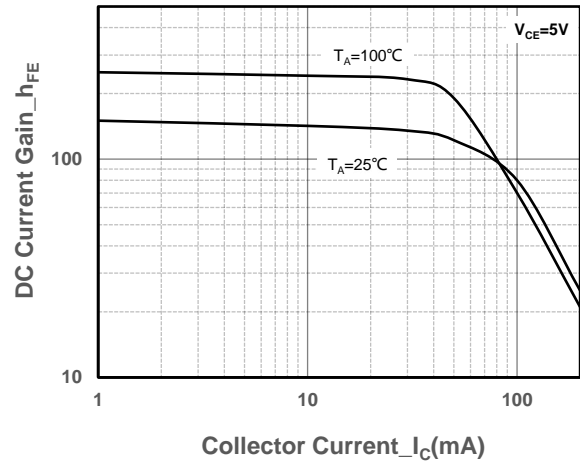

DC Current Gain vs. Collector Current

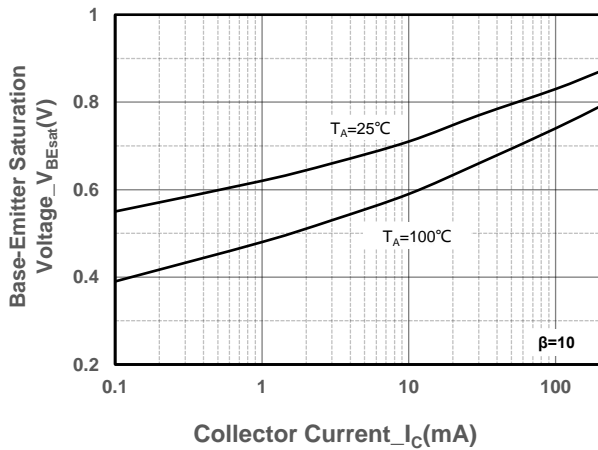

$V_{BE(sat)}$  vs. Collector Current

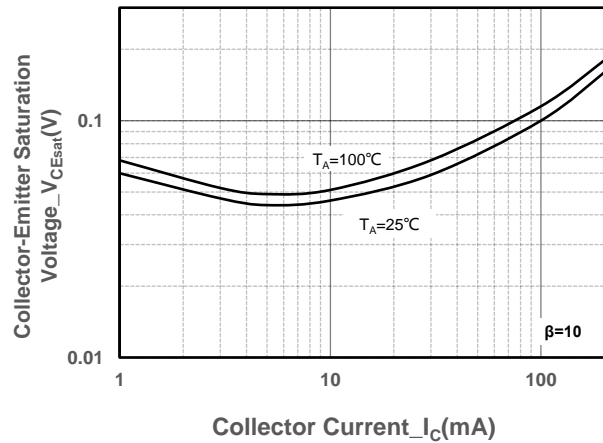

$V_{CE(sat)}$  vs. Collector Current

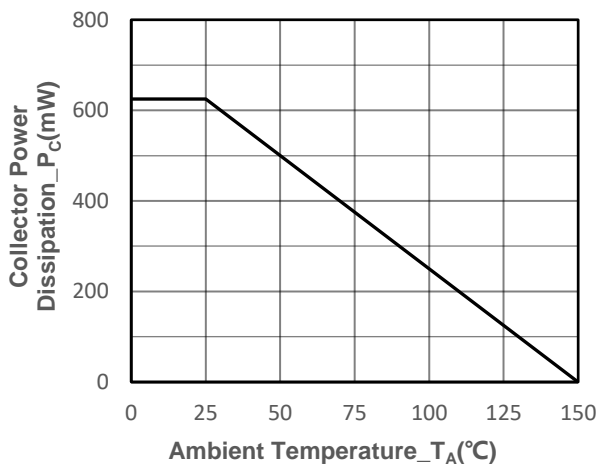

Power derating vs. Ambient temperature

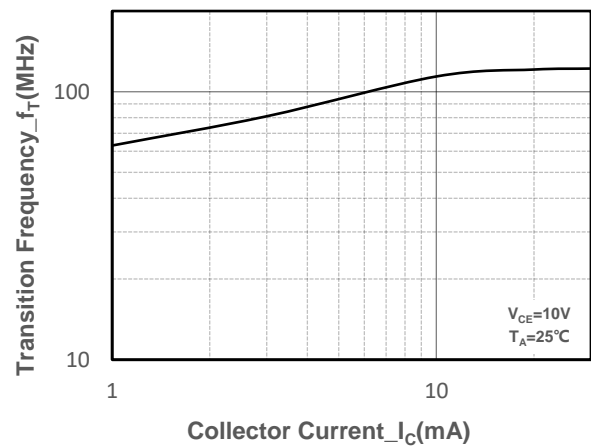

Transition Frequency vs. Collector Current



● Package Information

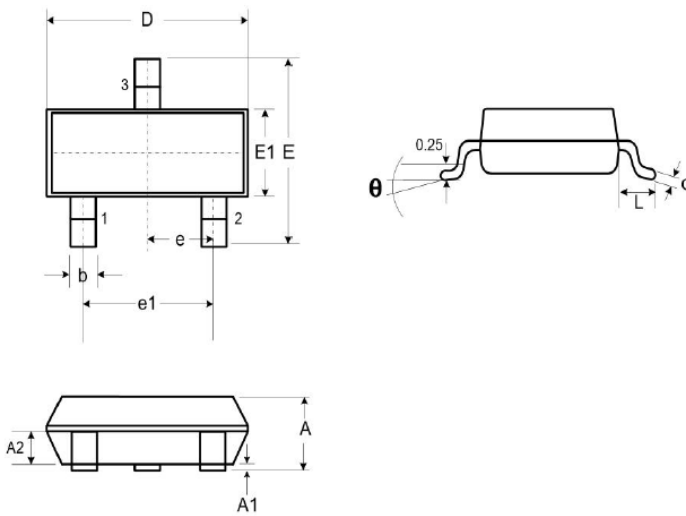

DIM	Millimeters		
	Min.	Typ.	Max.
A	0.89	-	1.12
A1	0.01	-	0.10
A2	0.88	0.95	1.02
b	0.30	-	0.51
c	0.08	-	0.18
D	2.80	2.90	3.04
E	2.10	2.37	2.64
E1	1.20	1.30	1.40
e	0.95		
e1	1.90		
L	0.40	0.50	0.60
L1	0.55		
N	3		
$\theta$	0°	-	8°

Recommended Pad outline(Unit: mm)

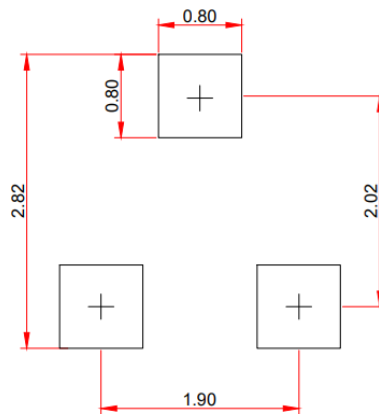



## DISCLAIMER

AFSEMI RESERVES THE RIGHT TO MAKE CHANGES WITHOUT FURTHER NOTICE TO ANY PRODUCTS HEREIN TO IMPROVE RELIABILITY, FUNCTION OR DESIGN. AFSEMI DOES NOT ASSUME ANY LIABILITY ARISING OUT OF THE APPLICATION OR USE OF ANY PRODUCT OR CIRCUIT DESCRIBED HEREIN; NEITHER DOES IT CONVEY ANY LICIENCE UNDER ITS PATENT RIGHTS, NOR THE RIGHTS OF OTHERS.

THE GRAPHS PROVIDED IN THIS DOCUMENT ARE STATISTICAL SUMMARIES BASED ON A LIMITED NUMBER OF SAMPLES AND ARE PROVIDED FOR INFORMATIONAL PURPOSE ONLY. THE PERFORMANCE CHARACTERISTICS LISTED IN THEM ARE NOT TESTED OR GUARANTEED. IN SOME GRAPHS, THE DATA PRESENTED MAY BE OUTSIDE THE SPECIFIED OPERATING RANGE (E.G., OUTSIDE SPECIFIED POWER SUPPLY RANGE ) AND THEREFORE OUTSIDE THE WARRANTED RANGE.